



SINCE 1973

PNEUMATIC TOOLS FOR PROFESSIONALS

 **MADE IN JAPAN**

VESSEL Co., Inc.
Osaka Japan
spair.vessel.co.jp/english/

VESSEL TOOLS U.S.A., INC.
www.spairusa.com/

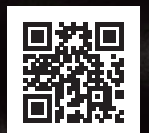

Impact
Ratchet Wren

Ratchet Wren

Impact Wren

Cut-off Tool

Reciprocating
Disk Grinder

Die Grinder

Beveler

Sander/Polis

Air Drill

Air Impact Dr

Air Hammer

Needle Scale

Impact Ratchet Wrench

Three times as fast as a standard air ratchet!

The impact mechanism is built into the air ratchet wrench, so that it can be tightened by the power of impact.

- It is safer because there is little backlash when tightening is completed.
- The rotation speed is more than Three times as fast as that of a normal ratchet, which makes tightening and loosening fast and easy.
- The speed of tightening can be adjusted by the built-in air regulator on the top rear of the tool.



SP-1764HD

1/4" SUPER FAST MINI IMPACT RATCHET
700rpm/ 55ft-lbs.

- Impact Mechanism [Patented].
- Built-in Power Regulator.
- Single Dog Clutch.



Scan to watch Demo Video

SP-1765HD

3/8" SUPER FAST MINI IMPACT RATCHET
700rpm/ 55ft-lbs.

700rpm/55ft-lbs.

Super Fast



SP-7260RP

1/4" THE PERFECT IMPACT RATCHET
600rpm/ 45ft-lbs.

- Sealed Head for Long Life.
- Impact Mechanism [Patented].
- Built-in Power Regulator.
- Single Dog Clutch.



Scan to watch Demo Video

SP-7265RP

3/8" THE PERFECT IMPACT RATCHET
600rpm/ 45ft-lbs.

600rpm/45ft-lbs.



Sealed Flat Ratchet Mechanism



SP-7730

3/8" REACTION FREE HIGH SPEED IMPACT RATCHET
450rpm/ 100ft-lbs.

- Impact Mechanism [Patented].
- Built-in Power Regulator.
- Reverse Lever.
- Single Dog Clutch.

450rpm/100ft-lbs.

Hight Torque



Model No.	Sq. Drive	Bolt Capacity	Max. Torque	Free Speed	Overall Length	Net Weight	Sound Level
SP-1764HD	1/4"	5/16"	55 ft-lbs.	700 rpm	6.9"	1.4 lbs.	84.4 dB
SP-1765HD	3/8"	3/8"	55 ft-lbs.	700 rpm	6.9"	1.4 lbs.	84.4 dB
SP-7260RP	1/4"	5/16"	45 ft-lbs.	600 rpm	7.5"	1.6 lbs.	88.1 dB
SP-7265RP	3/8"	3/8"	45 ft-lbs.	600 rpm	7.5"	1.6 lbs.	88.1 dB
SP-7730	3/8"	3/8"	100 ft-lbs.	450 rpm	11.6"	3.1 lbs.	88.2 dB

Ratchet Wrench



SP-7260

1/4" SEALED FLAT HEAD MINI RATCHET
290rpm/ 25ft-lbs.

- Sealed Head for Long Life.
- Reverse Lever for One-handed operation.
- Air Regulator.
- Swivel Air Inlet with 360° Exhaust Sleeve.



Light Weight

Sealed Flat Ratchet Mechanism



SP-7265

3/8" SEALED FLAT HEAD MINI RATCHET
290rpm/ 25ft-lbs.

SP-7265W

3/8" WOBBLE ANVIL SEALED FLAT HEAD MINI RATCHET

- Sealed Head for Long Life.
- Reverse Lever for One-handed operation.
- Air Regulator.
- Swivel Air Inlet with 360° Exhaust Sleeve.



Sealed Flat Ratchet Mechanism



SP-7780

3/8" HEAVY-DUTY SEALED FLAT HEAD RATCHET WRENCH [SHORT VERSION]
200rpm/ 80ft-lbs.

High Power

- Sealed Head for Long Life.
- Reverse Lever for One-handed operation.
- Air Regulator.
- 360° Exhaust Sleeve.



Sealed Flat Ratchet Mechanism



SP-7250H

LOW PROFILE 1/4" HEX. BIT DRIVER
290rpm/ 25ft-lbs.

- Sealed Head for Long Life.
- Reverse Lever for One-handed operation.
- Air Regulator.
- Swivel Air Inlet with 360° Exhaust Sleeve.

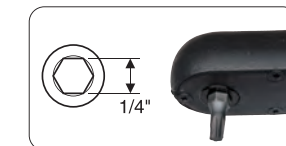

Broken Bit Knock Out Access



- Low profile for use in tight areas.
- Use with any 1/4" drive bit.
- Ratchet style for ease of use.

SP-7770

1/4" ROTATIONAL HEAD RATCHET WRENCH
220rpm/ 25ft-lbs.

- Reverse Lever.
- Built-in Air Regulator.
- Swivel Air Inlet and Rear Air Exhaust.



- To adjust head, slide the ring forward and turn the ratchet housing.



SP-7772

3/8" ROTATIONAL HEAD RATCHET WRENCH
220rpm/ 25ft-lbs.

- Reverse Lever.
- Built-in Air Regulator.
- Swivel Air Inlet and Rear Air Exhaust.



- To adjust head, slide the ring forward and turn the ratchet housing.



Model No.	Sq. Drive	Bolt Capacity	Max. Torque	Free Speed	Overall Length	Net Weight	Sound Level
SP-7260	1/4"	5/16"	25 ft-lbs.	290 rpm	8"	1.5 lbs.	87 dB
SP-7265	3/8"	3/8"	25 ft-lbs.	290 rpm	8"	1.5 lbs.	87 dB
SP-7265W	3/8"	3/8"	25 ft-lbs.	290 rpm	8"	1.5 lbs.	87 dB
SP-7770	1/4"	5/16"	25 ft-lbs.	220 rpm	7.9"	1.3 lbs.	82 dB
SP-7772	3/8"	3/8"	25 ft-lbs.	220 rpm	7.9"	1.3 lbs.	82 dB
SP-7780	3/8"	3/8"	80 ft-lbs.	200 rpm	9.75"	3.5 lbs.	82.6 dB

Model No.	Hex. Drive	Max. Torque	Free Speed	Overall Length	Net Weight	Sound Level
SP-7250H	1/4"	25 ft-lbs.	290 rpm	8"	1.5 lbs.	82 dB

Impact Wrench



SP-1140EX

1/2" HEAVY DUTY
IMPACT WRENCH

- Built-in Power Regulator.
- Twin Dog Clutch.



Twin Dog Clutch

- Twin dog clutch provides more power and smooth balanced blows.
- Produced 800ft-lbs. of bolt removing torque.
- Visual forward regulator with 4 torque settings and one full power reverse setting.

SP-7144

1/2" COMPOSITE IMPACT WRENCH



Twin Dog Clutch



SAS (Side And Side) System
Forward / Reverse for one hand operation.



Air Regulator
4 torque setting and full power reverse.

- Composite body greatly reduces weight to allow longer, fatigue free, operation when compared to heavier models with comparable torque and speed specifications.

SP-1140EXL

1/2" HEAVY DUTY
IMPACT WRENCH
w/ 2" EXTEND ANVIL

SP-7146EX

1/2" COMPOSITE
MINI IMPACT WRENCH



Twin Dog Clutch



SAS (Side And Side) System
Forward / Reverse for one hand operation.



Air Regulator
4 torque setting.

SP-7146EXS

3/8" COMPOSITE
MINI IMPACT WRENCH



SP-7825

3/8" COMPOSITE
MINI IMPACT WRENCH



Double Hammer Clutch



SAS (Side And Side) System
Forward / Reverse for one hand operation.



Air Regulator
4 torque setting.

SP-7825S

1/4" COMPOSITE
MINI IMPACT WRENCH



SP-1850

3/8" PALM IMPACT WRENCH



Double Hammer Clutch



Air Regulator
4 torque setting.

SP-1850S

1/4" PALM IMPACT WRENCH



Palm Size

SP-7150-V8

3/4" COMPOSITE IMPACT WRENCH



Twin Dog Clutch



SAS (Side And Side) System
Forward / Reverse for one hand operation.



Air Regulator
4 torque setting.



- Eight vane motor delivers hard-hitting torque of more than 1,000 ft-lbs.
- while housed in a composite housing weighing less than 8 lbs.

SP-1158

3/4" IMPACT WRENCH



Single Dog Clutch



Air Regulator
Forward, Reverse buton with 5 torque setting.



SP-1193GE-6

1" IMPACT WRENCH



Pinless Hammer Clutch

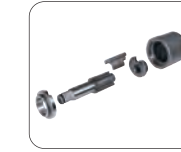

Air Regulator
Forward, Reverse torque setting.



SP-1194DX-6

1" IMPACT WRENCH



Twin Dog Clutch

Twin dog clutch assembly operates within an oil bath to provide long life and reduced noise.



Air Regulator
4 torque setting.



Model No.	Sq. Drive	Bolt Capacity	Max. Torque	Free Speed	Overall Length	Net Weight	Sound Level
SP-1140EX	1/2"	5/8"	800 ft-lbs.	6,000 rpm	7.5"	5.7 lbs.	88.8 dB
SP-1140EXL	1/2"	5/8"	800 ft-lbs.	6,000 rpm	9.5"	6.6 lbs.	88.8 dB
SP-7144	1/2"	5/8"	(F) 750 ft-lbs. (R) 800 ft-lbs.	(F) 5,700 rpm (R) 6,500 rpm	6.1"	4.0 lbs.	93.1 dB
SP-7146EX	1/2"	5/8"	440 ft-lbs.	10,000 rpm	5.2"	2.1 lbs.	93.1 dB
SP-7146EXS	3/8"	1/2"	380 ft-lbs.	10,000 rpm	5.2"	2.1 lbs.	93.1 dB
SP-7825	3/8"	3/8"	94 ft-lbs.	17,000 rpm	4.3"	1.5 lbs.	84.2 dB
SP-7825S	1/4"	3/8"	94 ft-lbs.	17,000 rpm	4.3"	1.5 lbs.	84.2 dB
SP-1850	3/8"	3/8"	72 ft-lbs.	10,000 rpm	5.4"	1.0 lbs.	87.4 dB
SP-1850S	1/4"	3/8"	72 ft-lbs.	10,000 rpm	5.4"	1.0 lbs.	87.4 dB

Model No.	Sq. Drive	Bolt Capacity	Max. Torque	Free Speed	Overall Length	Net Weight	Sound Level
SP-7150-V8	3/4"	1"	1,100 ft-lbs.	4,300 rpm	9.3"	7.9 lbs.	94.9 dB
SP-1158	3/4"	1"	1,200 ft-lbs.	5,500 rpm	8.7"	12.0 lbs.	93.5 dB
SP-1193GE-6	1"	1-1/2"	2,300 ft-lbs.	4,000 rpm	22.0"	28.7 lbs.	98.0 dB
SP-1194DX-6	1"	1-1/2"	1,800 ft-lbs.	4,800 rpm	20.6"	17.2 lbs.	96.7 dB

Cut-off Tool

SP-7230

CUT-OFF TOOL (DISC SIZE : 3")



- Ergonomic design cushion-grip handle.
- Rear exhaust. Safety throttle lever.
- Built-in power regulator.
- Direct drive motor. Graduated trigger.
- Metal guard. Cuts muffler clamps and hangers, sheet metal, radiator hose clamps, bumper bolts, and even steel rods up to 3/4".

SP-7231

FLEX HEAD CUT-OFF TOOL (DISC SIZE : 3")

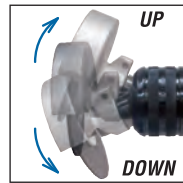

3-POSITION FLEX HEAD



- Built-in Power Regulator.
- Rear Exhaust.
- Safety Throttle Lever.

SP-7231R

REVERSIBLE FLEX HEAD CUT-OFF TOOL (DISC SIZE : 3")

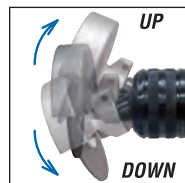

3-POSITION FLEX HEAD



Reversible

- Built-in Power Regulator.
- Rear Exhaust.
- Safety Throttle Lever.
- Reverse Lever.

7231AWC

ADJUSTABLE WHEEL COVER

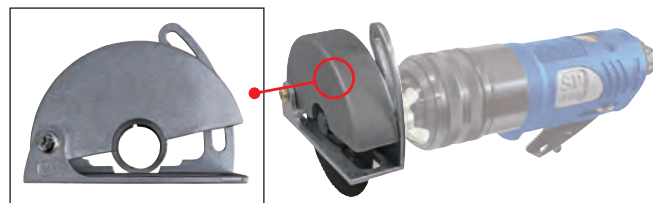

Fits SP AIR model # SP-7231, SP-7231R.
Fits also MAC AT35A (Mac Brand)
Adjustable cut depth (Minimum 1/8")

Model No.	Disc Size	Free Speed	Overall Length	Net Weight	Sound Level
SP-7230	3"	20,000 rpm	6-3/4"	1.5 lbs.	90.0 dB
SP-7231	3"	18,000 rpm	8.6"	2.6 lbs.	90.0 dB
SP-7231R	3"	12,000 rpm	8.8"	2.8 lbs.	90.0 dB

Reciprocating Saw/ Disk Grinder



SP-7234

4" EXTENDED REACH CUT-OFF TOOL

- Long Shaft.
- Wheel Cover.
- Safety Lever.
- Built-in Power Regulator.
- Rear Exhaust.



Accessories

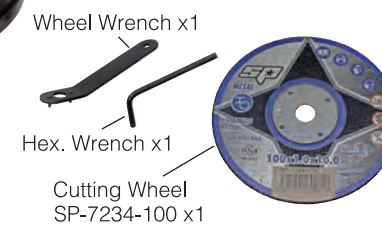

SP-1257

5" ANGLE DISC GRINDER [LEVER TYPE]

- Built-in governor mechanism.
- Safety lever.
- Handle grip mounts on either side for right or left hand operation.
- Hardened and ground spiral bevel gears for lower vibration.



SP-7610

RECIPROCATING SAW [GEAR TYPE]

- Adjustable Blade Guide.
- Safety Lever.
- Air Regulator.
- Cutting Capacity 5/32".



Tool Cutaway



Scan to watch Demo Video

Option



7610-200 Edge Blade
Durable 24 TPI blades.
(Set of 10pcs.)

Accessories



Compact Body

SP-7620

SHORT RECIPROCATING SAW [GEAR TYPE]

- Blade Guide.
- Safety Lever.
- Air Regulator.
- Cutting Capacity 5/64".



Model No.	Disc Size	Free Speed	Overall Length	Net Weight	Sound Level
SP-7234	4"	14,000 rpm	13.8"	3.3 lbs.	88.8 dB
SP-1257	5"	12,000 rpm	9.3"	3.7 lbs.	86.0 dB

Model No.	Strokes/min.	Stroke	Overall Length	Net Weight	Sound Level
SP-7610	5,300	0.47"	8.15"	1.3 lbs.	86.5 dB
SP-7620	7,500	0.24"	6.1"	1.0 lbs.	86.5 dB

Die Grinder



SP-7220

1/4" HEAVY-DUTY STRAIGHT DIE GRINDER



- Ergonomic design cushion-grip handle.
- Rear exhaust.
- Built-in power regulator.
- Safety throttle lever.
- Direct drive motor with graduated trigger.

SP-7212

1/4" HEAVY-DUTY 120 degree ANGLE HEAD DIE GRINDER



- 120 degree Angle head.
- Ergonomic design cushion-grip handle.
- Rear exhaust.
- Built-in power regulator.
- Safety throttle lever.

SP-7211

1/4" HEAVY-DUTY 90 degree ANGLE HEAD DIE GRINDER



- Ergonomic design cushion-grip handle. Rear exhaust.
- Built-in power regulator.
- Safety throttle lever.

SP-1900

1/8" MICRO GRINDER



- Rear exhaust.
- Flexible 59" long hose.

SP-7200

1/4" STRAIGHT DIE GRINDER



- Ergonomic design cushion-grip handle.
- Swivel Air Inlet with 360° Exhaust Sleeve.
- Built-in power regulator.
- Safety throttle lever.
- Direct drive motor with graduated trigger.

SP-7201

1/4" ANGLE HEAD DIE GRINDER



- 90 degree corner type.
- Anti-vibration ultra-soft grip.
- Easy adjustment of the regulator.
- Swivel inlet and exhaust.

SP-7202

1/4" ANGLE HEAD DIE GRINDER



- 120 degree corner type.
- Safety throttle lever.
- Urethane covered cushion grip.
- Built-in power regulator.
- 360 degrees rotating rear exhaust.

SP-4BS

CARBIDE BURR 4pc SET FOR FERROUS MATERIALS

- For use with 1/4" High Speed Die Grinders.
- For use in metalworking, mold and pattern making, die sinking, surface cleaning and maintenance.
- Removes Burrs from Sheet metal or cast iron.
- Cleans up welding areas.



CARBIDE BURRS

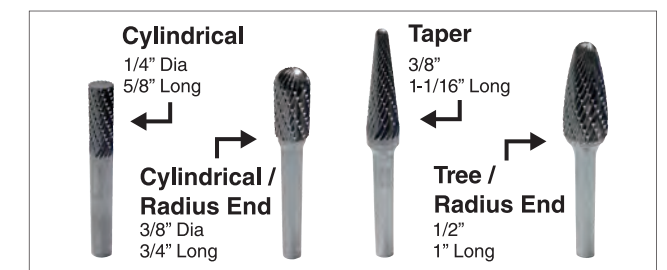

SP-4NF

CARBIDE BURR 4pc SET FOR ALUMINUM / NON-FERROUS MATERIALS

- Allowing rapid stock removal on nonferrous and plastics materials.
- Avoiding clogging.
- Ensures smooth cutting operation.
- Giving a guaranteed smoother grinding operation.



CARBIDE BURRS

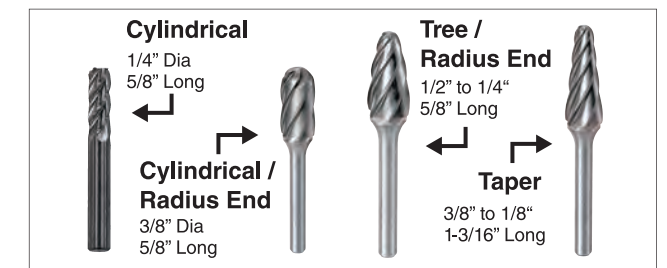

Model No.	Disc Size	Free Speed	Overall Length	Net Weight	Sound Level
SP-7220	1/4"	20,000 rpm	6-7/8"	1.37 lbs.	90.1 dB
SP-7211	1/4"	18,000 rpm	6-7/8"	1.75 lbs.	87.8 dB
SP-7212	1/4"	18,000 rpm	6-5/8"	1.69 lbs.	86.8 dB
SP-1900	1/4"	70,000 rpm	6" (w/o hose)	0.9 lbs. (w/o hose)	78.3 dB

Model No.	Disc Size	Free Speed	Overall Length	Net Weight	Sound Level
SP-7200	1/4"	23,000 rpm	6"	0.88 lbs	82.0 dB
SP-7201	1/4"	20,000 rpm	6-3/8"	1.25 lbs	82.4 dB
SP-7202	1/4"	20,000 rpm	7.6"	1.23 lbs	83.0 dB

Beveler

SP-7252F
AIR MINI BEVELER
[STRAIGHT]

SP-7252FR
AIR MINI BEVELER
[RADIUS]

Palm Size



- Safety Throttle Lever.
- Front Exhaust for cooling metal.



Scan to watch Demo Video

- Use the Palm Beveler to; Clean up the welds, Beveling steel or aluminum edges for Custom work, Automotive, Motorcycles, Marine and Aircraft uses.
- 45° Straight and Radius Blade available.

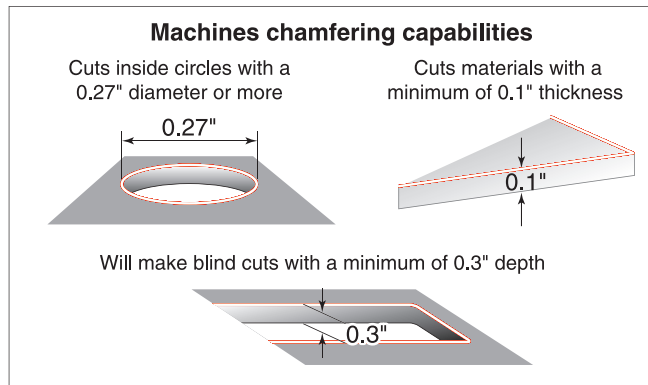
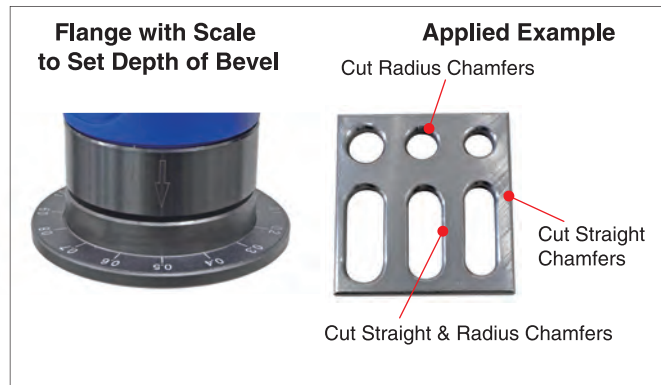
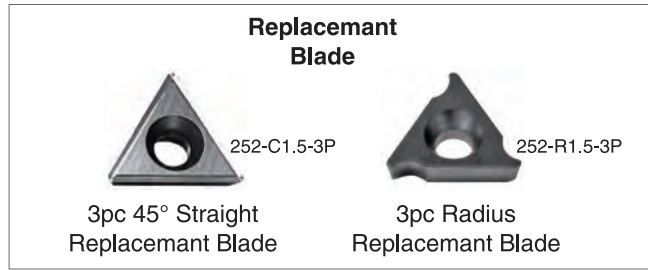
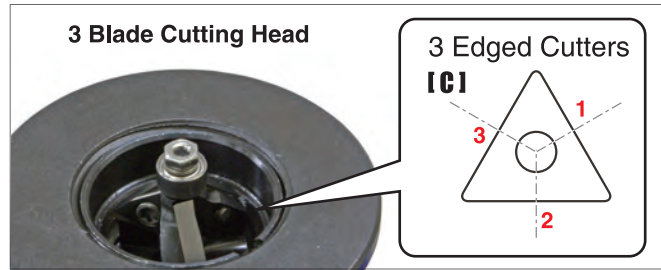

Model No.	Min. Diameter	Chamfering Capacity	Free Speed	Overall Length	Net Weight	Sound Level
SP-7252F	0.27"	C45° 0.06"	23,000 rpm	4.4"	0.9 lbs.	81.5 dB
SP-7252FR	0.27"	R0.06"	23,000 rpm	4.4"	0.9 lbs.	81.5 dB

Sander/ Polisher



SP-1350
5" HIGH SPEED SANDER

- Handle Exhaust with Silencer.
- Rubber Cover.



Compact and Lightweight

SP-7201DA
2" MINI D/A SANDER

- Swivel Air Inlet with 360° Exhaust Sleeve.



Compact and Lightweight

2" SANDING DISC 180 GRIT

25 Pack #7201DA-18025P
50 Pack #7201DA-18050P
100 Pack #7201DA-180100P

2" SANDING DISC 320 GRIT

25 Pack #7201DA-32025P
50 Pack #7201DA-32050P
100 Pack #7201DA-320100P

SP-7500AHM

3" MINI POLISHER

- Swivel Air Inlet with 360° Exhaust Sleeve.
- Spindle Size: 5/16-24UNF.
- Air Regulator.

LOW SPEED SINGLE ACTION

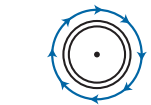

- Well Balanced.
- More Powerful.
- Wide Range of Uses.
- Polish Small Areas.
- Polish Complex Shapes.

3" 100% Twist Wool Pad



Model No.	Disc Size	Free Speed	Overall Length	Net Weight	Sound Level
SP-1350	3" & 5"	15,000 rpm	5"	2.1 lbs.	77.8 dB
SP-7201DA	2"	12,000 rpm	6.3"	1.3 lbs.	87.9 dB
SP-7500AHM	3"	2,500 rpm	7.9"	1.7 lbs.	85.8 dB

Model No.	Belt Size	Free Speed	Overall Length	Net Weight	Sound Level
SP-1370A	3/8" & 1/2" x 13"	16,000 rpm	11"	1.7 lbs.	82.0 dB
SP-1380	3/4" x 20-1/2"	17,000 rpm	14.4"	3.1 lbs.	85.5 dB

SP-1370A
3/8" & 1/2" x 13" BELT SANDER

- Quick change belt guide allows belt replacement in seconds.

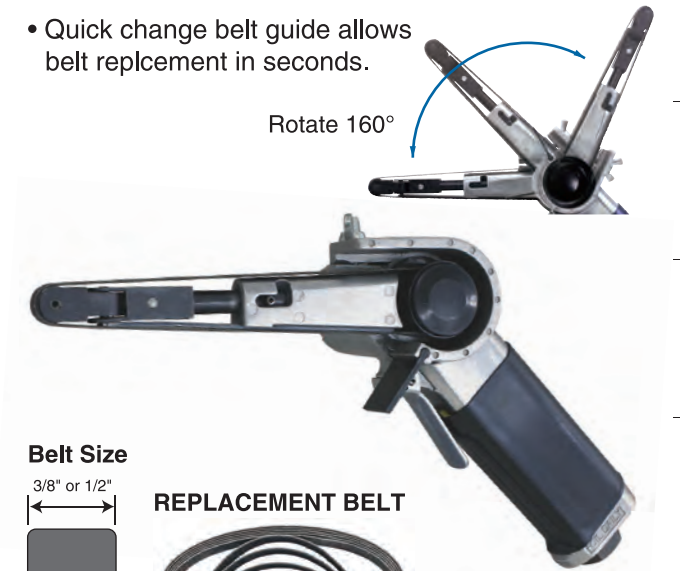

Belt Size

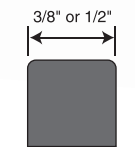

REPLACEMENT BELT



370-80-5P (60 Grit 3/8"x13")
Replacement Belt 5 Pack

370-80-10P (60 Grit 3/8"x13")
Replacement Belt 10 Pack

SP-1380

3/4" x 20-1/2" BELT SANDER

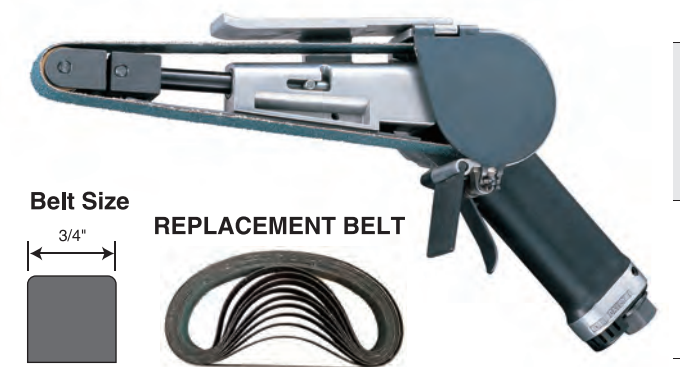

Belt Size

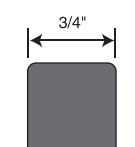

REPLACEMENT BELT



380-60-5P (60 Grit 3/4"x20.5")
Replacement Belt 5 Pack

380-60-10P (60 Grit 3/4"x20.5")
Replacement Belt 10 Pack

Air Drill

SP-7527

1/2" COMPOSITE AIR DRILL

400rpm

- 1/2"(13mm) Drill Chuck.
- Light Weight Composite Body.

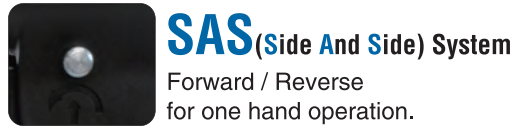
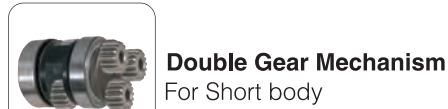

SP-1523D

3/8" STRAIGHT DRILL / TIRE BUFFER

- Precision drill chuck.
- Lever type.
- Right rotation only.



SP-7527KL

1/2" COMPOSITE AIR DRILL [KEYLESS CHUCK]

400rpm

- 1/2"(13mm) Keyless Drill Chuck.
- Light Weight Composite Body.

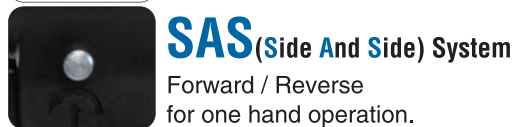
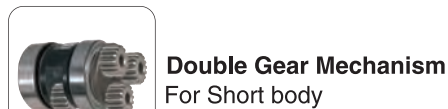

Model No.	Chuck Size	Free Speed	Overall Length	Net Weight	Sound Level
SP-7527	1/2"	400 rpm	7"	2.9 lbs.	86.8 dB
SP-7527KL	1/2"	400 rpm	7.1"	2.9 lbs.	86.8 dB
SP-1523D	3/8"	3,800 rpm	7.5"	1.59 lbs.	83.0 dB

Air Impact Driver



SP-7825HU

1/4" HEX. COMPOSITE IMPACT DRIVER

1/4" Hexagonal

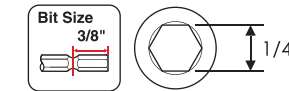

Ultralight

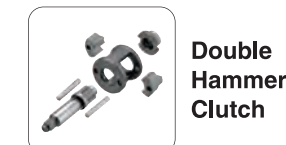

SP-8102BU

1/4" HEX. IMPACT DRIVER

1/4" Hexagonal

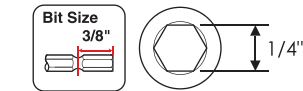

SP-7146HX

1/4" HEX. COMPOSITE IMPACT DRIVER

1/4" Hexagonal

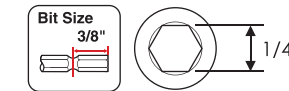

Ultralight

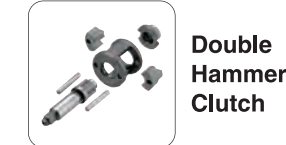

Model No.	Hex. Drive	Max. Torque	Free Speed	Overall Length	Net Weight	Sound Level
SP-7825HU	1/4"	94 ft.-lbs.	17,000 rpm	4.7"	1.5 lbs.	85.5 dB
SP-7146HX	1/4"	100 ft.-lbs.	8,500 rpm	5.3"	2.1 lbs.	92.0 dB
SP-8102BU	1/4"	100 ft.-lbs.	11,500 rpm	6"	2.6 lbs.	90.0 dB

Air Hammer

SP-1400

LONG BARREL AIR HAMMER



- For industrial and auto repair applications.
- Ideal for general cutting, body panel crimping, shearing, rust/paint removal, chipping and scraping.
- Comfortable non-slip ergonomic grip.
- Graduated trigger control.
- Built-in air regulator.
- Quick change coil spring retainer allows for fast and easy chisel changes.
- Handle exhaust.

SP-1405

SHORT BARREL AIR HAMMER



- For industrial and auto repair applications.
- Ideal for general cutting, body panel crimping, shearing, rust/paint removal, chipping and scraping.
- Comfortable non-slip ergonomic grip.
- Graduated trigger control.
- Built-in air regulator.
- Quick change coil spring retainer allows for fast and easy chisel changes.
- Handle exhaust.

SP-1410

AIR HAMMER



- Variable speed trigger.
- Built-in regulator.
- Quick change coil spring retainer allows for fast and easy chisel changes.

SP-1410K

AIR HAMMER KIT

Accessories

- Sheet metal chisel
- Flat chisel
- Tapered punch chisel
- Spot welder chisel



Model No.	Shank Size	Free Speed	Overall Length	Net Weight	Sound Level
SP-1400	0.4"	2,100 rpm	8.5"	3.6 lbs.	96 dB
SP-1405	0.4"	3,000 rpm	6.5"	2.6 lbs.	100 dB
SP-1410/ SP-1410K	0.4"	3,000 rpm	8.5"	3.6 lbs.	96 dB



Needle Scaler

SP-1460

NEEDLE SCALER [SMALL]



SP-1470

NEEDLE SCALER [LARGE]

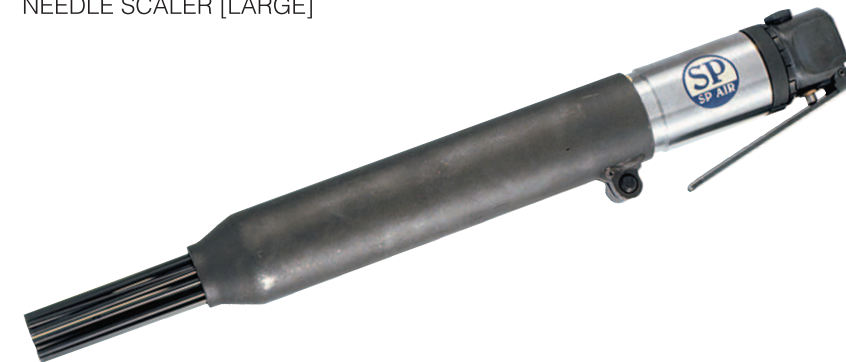

Model No.	Bore	Stroke	Needle	Blows/min.	Overall Length	Net Weight	Vibration Level A
SP-1460	3/4"	1/2"	1/8" x 12 pcs	5,000	9"	2.8 lbs.	27.87 m/s ²
SP-1470	1"	7/8"	1/8" x 19 pcs	4,000	16"	5.7 lbs.	31.68 m/s ²