

# A Long Lasting Technology

Breakage of a screwdriver bit not only reduces work efficiency but also adversely affects the quality of an assembled product. Improving durability of a screwdriver bit is a critical issue for assembly lines.

## Pursuit of Durability

Alloy Steel including substances such as C, Si, Ni, Cr, Mo, and V, which gives a high hardness and toughness, is heat treated by our own furnace and technology in order to make our screwdriver bits outstanding quality and durability. "VoHA" steel is compounded a special alloy element used for materials in aerospace industry. Combination with NECK TORSION™ technology, it is possible to dramatically reduce the breakage of the bit tip.

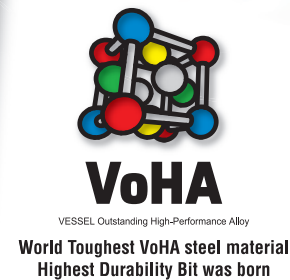
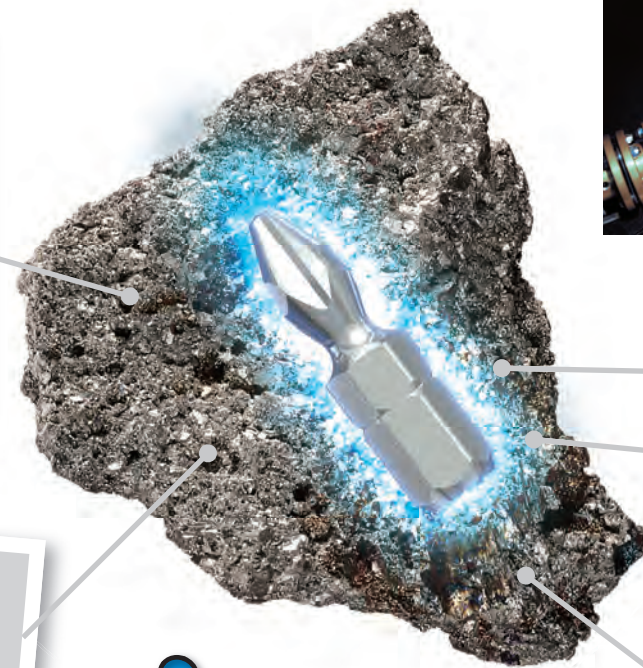
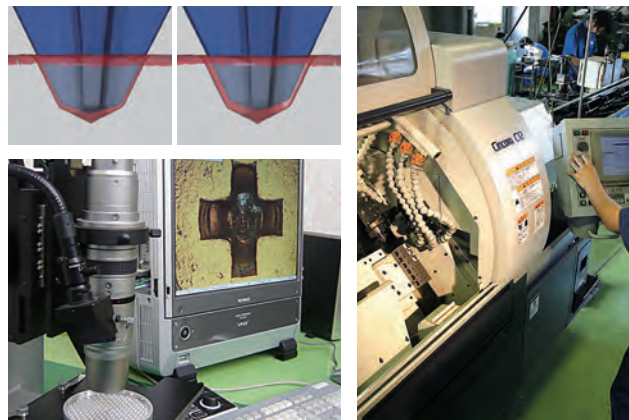

## Tip Toughness Test

Torsion force is increased until failure and to show the highest torque value.

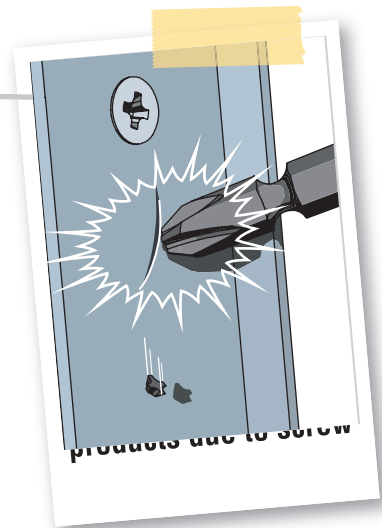
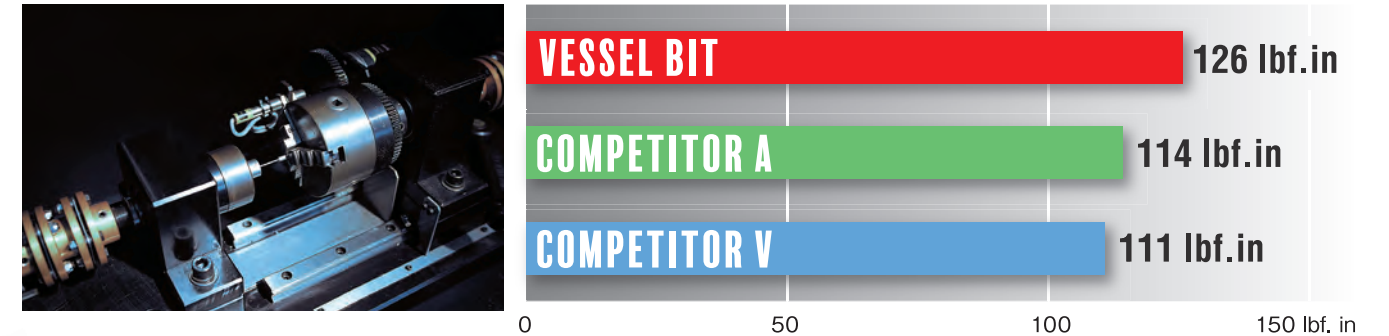

## Precision Fitting

Screwdriver bits are produced with less variation by improvement of machining accuracy with superior machines and thorough quality control. The tip profile is thoroughly analyzed for fitting well with screws using a 3D digitizer. Ideal fitting not only prevents stripping a screw head but also improves the durability of screwdriver bit.



## Selecting Phillips tip according to hardness classification

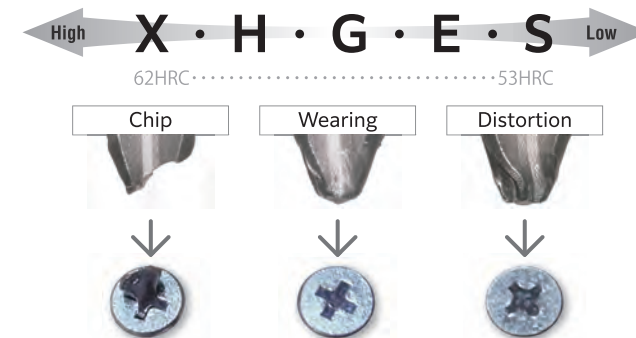

Easy to fracture when a bit is higher than optimum hardness  
Easy to wear-out or distort when a bit is lower than optimum hardness

## Mag Applied Technology

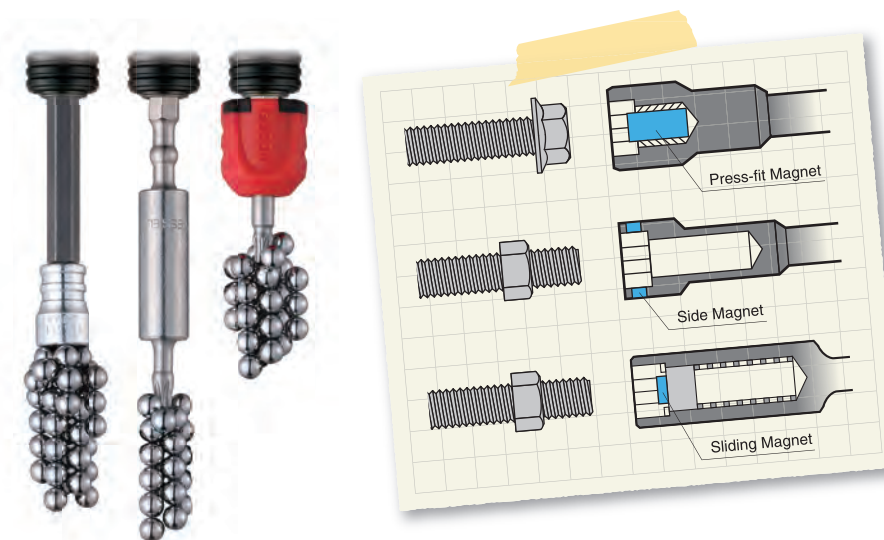

Hold a screw with strong magnetic force. Magnet applied technology is a significantly effective tools for the prevention of screw fall-off during work. A wide variety of products are offered depending upon each work application.

# Insert Bits



## NECK TORSION

It absorbs and reduces vibration occurred during screwing into tree knots, tapping, and such application.

It suppresses bounce of a bit itself and can be expected improvement of work efficiency and long life of a bit.

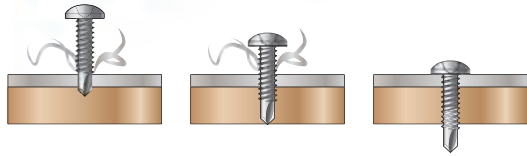

Drive : 1/4 DIN 3126-C6.3, ISO 1173  H 6.35 mm

## 1/4" Hex NECK TORSION™ Insert Bit



Model No.	Tip Size	Overall Length	Hardness	Inner Ctn.	Code
NTPH1254P3	PH1	25.4	X	3PC/Carded	426001
NTPH2254P3	PH2	25.4	X	3PC/Carded	426002
NTPH3254P3	PH3	25.4	X	3PC/Carded	426003
NTPH2254P5	PH2	25.4	X	5PC/Carded	426004
NTPH2254P25T	PH2	25.4	X	25PC/TiC/Tac	426041
NTPH1254P25K	PH1	25.4	X	25	426042
NTPH2254P25K	PH2	25.4	X	25	426043
NTPH3254P25K	PH3	25.4	X	25	426044

## 1/4" Hex NECK TORSION™ Insert Bit



Model No.	Tip Size	Overall Length	Hardness	Inner Ctn.	Code
NTTX15254P3	T15	25.4	X	3PC/Carded	426005
NTTX20254P3	T20	25.4	X	3PC/Carded	426006
NTTX25254P3	T25	25.4	X	3PC/Carded	426007
NTTX10254P25K	T10	25.4	X	25	426045
NTTX15254P25K	T15	25.4	X	25	426046
NTTX20254P25K	T20	25.4	X	25	426047
NTTX25254P25K	T25	25.4	X	25	426048
NTTX30254P25K	T30	25.4	X	25	426049

## 1/4" Hex NECK TORSION™ Insert Bit

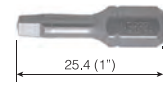

Model No.	Tip Size	Overall Length	Hardness	Inner Ctn.	Code
NTSQ1254P3	SQ1	25.4	X	3PC/Carded	426008
NTSQ2254P3	SQ2	25.4	X	3PC/Carded	426009
NTSQ3254P3	SQ3	25.4	X	3PC/Carded	426010
NTSQ1254P25K	SQ1	25.4	X	25	426050
NTSQ2254P25K	SQ2	25.4	X	25	426051
NTSQ3254P25K	SQ3	25.4	X	25	426052

## 1/4" Hex Insert Bit



Model No.	Tip Size	Overall Length	Hardness	Inner Ctn.	Code
B33P03254H	PH0	25.4	H	10	426124
B33P1254H	PH1	25.4	H	10	421231
B33P145254H	PH1	25.4	H	10	426120
B33P2254H	PH2	25.4	H	10	421241
B33P25254H	PH2	25.4	H	10	426125
B33P3254G	PH3	25.4	G	10	421242

## 1/4" Hex Insert Bit

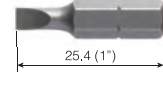

Model No.	Tip Width/ Shank Diameter	Overall Length	Hardness	Inner Ctn.	Code
B33S4254G	4	25.4	G	10	421251
B33S6254G	6	25.4	G	10	421252

## 1/4" Hex Insert Bit

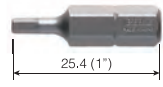

Model No.	Tip Size	Overall Length	Hardness	Inner Ctn.	Code
B33H2254H	H2	25.4	H	10	421260
B33H25254H	H2.5	25.4	H	10	421261
B33H3254H	H3	25.4	H	10	421262
B33H4333H	H4	33	H	10	421263
B33H5333H	H5	33	H	10	421264
B33H6333H	H6	33	H	10	421265

## 1/4" Hex Insert Bit

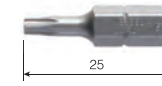

Model No.	Tip Size	Overall Length	Inner Ctn.	Code
B33T325H	T3	25	10	489154
B33T525H	T5	25	10	489155
B33T6254H	T6	25.4	10	635400
B33T725H	T7	25	10	489157
B33T8254H	T8	25.4	10	635401
B33T10254H	T10	25.4	10	635402
B33T15254H	T15	25.4	10	635403
B33T20254H	T20	25.4	10	635404
B33T25254H	T25	25.4	10	635405
B33T27254H	T27	25.4	10	635406
B33T30254H	T30	25.4	10	635407
B33T40254H	T40	25.4	10	635408

## 1/4" Hex Insert Bit

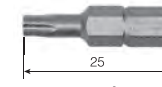

Model No.	Tip Size	Overall Length	Hardness	Inner Ctn.	Code
B33IP1525H	15IP	25	H	10	447204
B33IP2025H	20IP	25	H	10	447205
B33IP2525H	25IP	25	H	10	447206
B33IP3025H	30IP	25	H	10	447207
B33IP4025H	40IP	25	H	10	447208

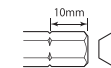
Drive : 5/16 DIN 3126-C8, ISO 1173  H 8 mm

## 5/16" Hex Insert Bit

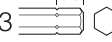

Model No.	Tip Size	Overall Length	Inner Ctn.	Code
A5T3032H	T30	32	10	635427
A5T4032H	T40	32	10	635428
A5T4532H	T45	32	10	635429
A5T5032H	T50	32	10	635430

Drive : 1/4 DIN 3126-C6.3, ISO 1173  H 6.35 mm

## Magnet Screw Catcher

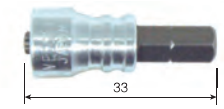

Model No.	Tip Size	Overall Length	Inner Ctn.	Code
B33MMBCP133H	PH1	33	10	447105
B33MMBCP233H	PH2	33	10	447106

## Magnet Screw Catcher

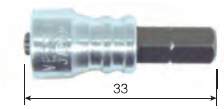

Model No.	Tip Size	Overall Length	Inner Ctn.	Code
B33MMBCPZ133H	PZ1	33	10	447107
B33MMBCPZ233H	PZ2	33	10	447108

## Magnet Screw Catcher

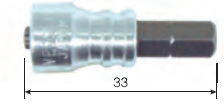

Model No.	Tip Size	Overall Length	Inner Ctn.	Code
B33MMBCT1033H	T10	33	10	447104
B33MMBCT1533H	T15	33	10	447102
B33MMBCT2033H	T20	33	10	447103
B33MMBCT2533H	T25	33	10	447110

## Replacement Bits For MMBC Series

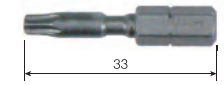

Model No.	Tip Size	Overall Length	Inner Ctn.	Code
B33MMBCT1033HRB	T10	33	10	447329
B33MMBCT1533HRB	T15	33	10	447330
B33MMBCT2033HRB	T20	33	10	447331
B33MMBCT2533HRB	T25	33	10	447332
B33MMBCP133HRB	PH1	33	10	447333
B33MMBCP233HRB	PH2	33	10	447334
B33MMBCPZ133HRB	PZ1	33	10	447335
B33MMBCPZ233HRB	PZ2	33	10	447336

# Power Bits

Drive : 1/4 DIN 3126-E6.3, ISO 1173 

## 1/4" Hex NECK TORSION™ Power Bit

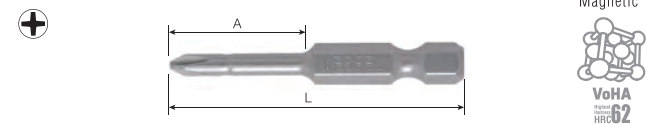

Model No.	Tip Size	Overall Length	Length (A)	Hardness	Inner Ctn.	Code
NTPH150P2	PH1	50	25	X	2PC/Carded	426017
NTPH250P2	PH2	50	25	X	2PC/Carded	426018
NTPH350P2	PH3	50	25	X	2PC/Carded	426021
NTPH250P5	PH2	50	25	X	5PC/Carded	426022
NTPH250P15T	PH2	50	25	X	15PC/TicTac	426029
NTPH150P25K	PH1	50	25	X	25	426053
NTPH250P25K	PH2	50	25	X	25	426054
NTPH350P25K	PH3	50	25	X	25	426055
NTPH275P2	PH2	75	25	X	2PC/Carded	426019
NTPH275P10K	PH2	75	25	X	10	426062
NTPH2150P1	PH2	150	100	X	1PC/Carded	426020
NTPH2150P10K	PH2	150	100	X	10	426063

## 1/4" Hex NECK TORSION™ Power Bit

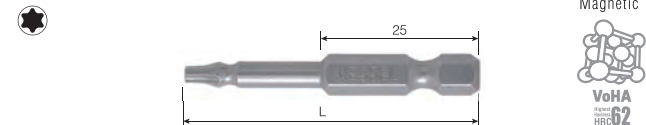

Model No.	Tip Size	Overall Length	Hardness	Inner Ctn.	Code
NTTX1550P2	T15	50	X	2PC/Carded	426023
NTTX2050P2	T20	50	X	2PC/Carded	426024
NTTX2550P2	T25	50	X	2PC/Carded	426025
NTTX1550P25K	T15	50	X	25	426056
NTTX2050P25K	T20	50	X	25	426057
NTTX2550P25K	T25	50	X	25	426058

## 1/4" Hex NECK TORSION™ Power Bit

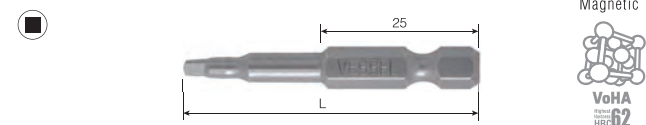

Model No.	Tip Size	Overall Length	Hardness	Inner Ctn.	Code
NTSQ150P2	SQ1	50	X	2PC/Carded	426026
NTSQ250P2	SQ2	50	X	2PC/Carded	426027
NTSQ350P2	SQ3	50	X	2PC/Carded	426028
NTSQ150P25K	SQ1	50	X	25	426059
NTSQ250P25K	SQ2	50	X	25	426060
NTSQ350P25K	SQ3	50	X	25	426061

## 1/4" Hex Power BIT



Model No.	Tip Size	Overall Length	Hardness	Body Diameter	Inner Ctn.	Code
B35P00122060H	PH00	60	H	1.2	10	446126
B35P0015849H	PH00	49	H	1.58	10	446423
B35P00240100H	PH00	100	H	2.0	10	446141
B35P031749H	PH0	49	H	3.17	10	487195
B35P0143060H	PH0	60	H	1.4	10	446145
B35P022060H	PH0	60	H	2.0	10	446153
B35P0230100H	PH0	100	H	2.0	10	446157
B35P150H	PH1	50	H	7	10	424032
B35P175H	PH1	75	H	7	10	424035
B35P145100H	PH1	100	H	4.5	10	424036
B35P14889H	PH1	89	H	4.8	10	487202
B35P248100H	PH2	100	H	4.8	10	446429
B35P26100H	PH2	100	H	6	10	489255
B35P26150H	PH2	150	H	6	10	489673
B35P26200H	PH2	200	H	6	10	446439
B35P263549H	PH2	49	H	6.4	10	487205
B35P263570H	PH2	70	H	6.35	10	487206
B35P263589H	PH2	89	H	6.35	10	487207
B35P2635152H	PH2	152	H	6.35	10	487208
B35P250X	PH2	50	X	7	10	424061
B35P250G	PH2	50	G	7	10	424040
B35P275X	PH2	75	X	7	10	424062
B35P275H	PH2	75	H	7	10	424047
B35P275G	PH2	75	G	7	10	424041
B35P275E	PH2	75	E	7	10	424042
B35P2775100H	PH2	100	H	7	10	424048
B35P2100G	PH2	100	G	7	10	424043
B35P2100E	PH2	100	E	7	10	424044
B35P2150H	PH2	150	H	7	10	424049
B35P2150G	PH2	150	G	7	10	424045
B35P2150E	PH2	150	E	7	10	424046
B35P245100H	PH2	100	H	4.5	10	424038
B35P349H	PH3	49	H	7.9	10	487210
B35P389H	PH3	89	H	7.9	10	487212
B35P375H	PH3	75	H	7	10	424050
B35P375E	PH3	75	E	7	10	424051
B35P3100H	PH3	100	H	7	10	424052
B35P3100E	PH3	100	E	7	10	424053
B35P3150G	PH3	150	G	7	10	424054

## 1/4" Hex Power BIT



Model No.	Overall Length	Hardness	Tip Width/ Shank Diameter	Inner Ctn.	Code
B35S675E	75	E	6	10	424075
B35S6351049H	49	H	6.35	10	487245
B35S791249H	49	H	7.9	10	487255

## 1/4" Hex Power BIT

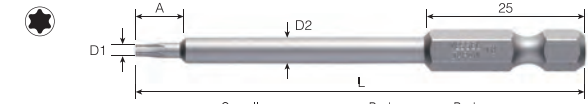

Model No.	Tip Size	Overall Length	Length (A)	Body Diameter(D1)	Body Diameter(D2)	Inner Ctn.	Code
B35T549H	T5	49	6.5	1.67	3.18	10	446486
B35T570H	T5	70	6.5	1.67	3.18	10	447355
B35T589H	T5	89	6.5	1.67	3.18	10	447356
B35T675H	T6	75	6.5	1.95	3.96	10	635300
B35T6100H	T6	100	6.5	1.95	3.96	10	635301
B35T6152H	T6	152	6.5	1.95	3.18	10	447317
B35T770H	T7	70	6.5	2.27	3.18	10	446499
B35T775H	T7	75	6.5	2.27	4	10	635303
B35T790H	T7	90	6.5	2.27	3.18	10	446509
B35T7152H	T7	152	6.5	2.27	3.18	10	446519
B35T849H	T8	49	7.0	2.6	3.18	10	446489
B35T870H	T8	70	7.0	2.6	3.18	10	446500
B35T875H	T8	75	7.0	2.6	4.5	10	635305
B35T890H	T8	90	7.0	2.6	3.18	10	446510
B35T8100H	T8	100	7.0	2.6	4.5	10	635306
B35T8152H	T8	152	7.0	2.6	3.18	10	446520
B35T970H	T9	70	7.0	2.78	3.18	10	446501
B35T990H	T9	90	7.0	2.78	3.18	10	446511
B35T9152H	T9	152	7.0	2.78	3.18	10	446521
B35T1049H	T10	49	7.5	3.02	3.96	10	446491
B35T1070H	T10	70	7.5	3.02	3.96	10	446502
B35T1075H	T10	75	7.5	3.02	4.5	10	635310
B35T10100H	T10	100	7.5	3.02	4.5	10	635311
B35T10152H	T10	152	7.5	3.02	3.96	10	446522
B35T1549H	T15	49	7.5	3.56	3.96	10	446492
B35T1570H	T15	70	7.5	3.56	3.96	10	446503
B35T1575H	T15	75	7.5	3.56	4.5	10	635315
B35T1590H	T15	90	7.5	3.56	3.96	10	446513
B35T15100H	T15	100	7.5	3.56	4.5	10	635316
B35T15152H	T15	152	7.5	3.56	3.96	10	446523
B35T2049H	T20	49	4.75	4.14	4.75	10	446493
B35T2070H	T20	70	4.75	4.14	4.75	10	446504
B35T2075H	T20	75	7.5	4.14	5	10	635320
B35T20100H	T20	100	7.5	4.14	5	10	635321
B35T20152H	T20	152	7.5	4.14	4.37	10	446524
B35T2570H	T25	70	8.0	4.7	5	10	446505
B35T2575H	T25	75	8.0	4.7	5	10	635325
B35T25100H	T25	100	8.0	4.7	5	10	635326
B35T25152H	T25	152	8.0	4.7	4.75	10	446525
B35T2775H	T27	75	8.0	5.26	5.5	10	635330
B35T27100H	T27	100	8.0	5.26	5.5	10	635331
B35T27152H	T27	152	8.0	5.26	6.4	10	446526
B35T3070H	T30	70	8.5	5.79	6.4	10	446507
B35T3075H	T30	75	8.5	5.79	6	10	635335
B35T3090H	T30	90	8.5	5.79	6.4	10	446517
B35T30100H	T30	100	8.5	5.79	6	10	635336
B35T30152H	T30	152	8.5	5.79	6.4	10	446527
B35T4049H	T40	49	-	7	10	446497	
B35T4070H	T40	70	-	8	10	446508	
B35T4075H	T40	75	-	8	10	635340	
B35T4090H	T40	90	-	8	10	446518	
B35T40100H	T40	100	-	7	10	635341	

Model No.	Tip Size	Overall Length	Length (A)	Body Diameter(D1)	Body Diameter(D2)	Inner Ctn.	Code
B35T40152H	T40	152	-	-	8	10	446528
B35T4575H	T45	75	-	-	7.9	10	635345
B35T45100H	T45	100	-	-	7.9	10	635346

## 1/4" Hex Power BIT

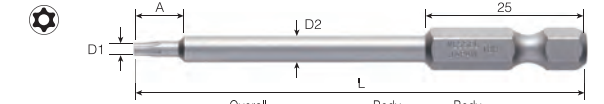

Model No.	Tip Size	Overall Length	Length (A)	Body Diameter(D1)	Body Diameter(D2)	Inner Ctn.	Code
B35T6H75H	T6H	75	6.5	1.95	3.96	10	635283
B35T6H100H	T6H	100	6.5	1.95	3.96	10	635284
B35T8H75H	T8H	75	7.0	2.60	4.5	10	635285
B35T8H100H	T8H	100	7.0	2.60	4.5	10	635286
B35T10H49H	T10H	49	7.5	3.02	3.96	10	446533
B35T10H70H	T10H	70	7.5	3.02	3.96	10	446544
B35T10H75H	T10H	75	7.5	3.02	4.5	10	635251
B35T10H100H	T10H	100	7.5	3.02	4.5	10	635252
B35T15H75H	T15H	75	7.5	3.56	4.5	10	635255
B35T15H100H	T15H	100	7.5	3.56	4.5	10	635256
B35T20H49H	T20H	49	7.5	4.14	4.37	10	446535
B35T20H70H	T20H	70	7.5	4.14	4.37	10	446546
B35T20H75H	T20H	75	7.5	4.14	5	10	635261
B35T20H100H	T20H	100	7.5	4.14	5	10	635262
B35T25H75H	T25H	75	8.0	4.70	5	10	635265
B35T25H100H	T25H	100	8.0	4.70	5	10	635266
B35T27H75H	T27H	75	8.0	5.26	5.5	10	635271
B35T27H100H	T27H	100	8.0	5.26	5.5	10	635272
B35T30H75H	T30H	75	8.5	5.79	6	10	635275
B35T30H100H	T30H	100	8.5	5.79	6	10	635276
B35T40H75H	T40H	75	-	-	7	10	635281
B35T40H100H	T40H	100	-	-	7	10	635282

## 1/4" Hex Power BIT

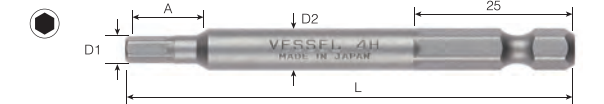

Model No.	Tip Size	Overall Length	Length (A)	Body Diameter(D1)	Body Diameter(D2)	Hardness	Inner Ctn.	Code
B35H275H	H2	75	9.5	2.35	7	H	10	424080
B35H2100H	H2	100	9.5	2.35	7	H	10	424081
B35H2575H	H2.5	75	9.5	2.9	7	H	10	424082
B35H25100H	H2.5	100	9.5	2.9	7	H	10	424083
B35H25150H	H2.5	150	9.5	2.9	7	H	10	424093
B35H375H	H3	75	10	3.55	7	H	10	424084

# Power Bits/ Mag Catcher

Drive : 1/4 DIN 3126-E6.3, ISO 1173  H 6.35mm

## 1/4" Hex Power BIT

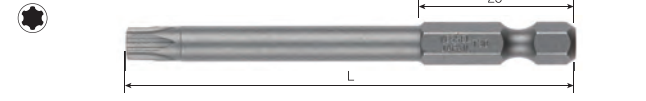

Model No.	Tip Size	Overall Length	Hardness	Body Diameter	Inner Ctn.	Code
B35IP6152H	6IP	152	H	1.64	10	447251
B35IP7152H	7IP	152	H	1.99	10	447252
B35IP8152H	8IP	152	H	2.31	10	447253
B35IP949H	9IP	49	H	2.5	10	447229
B35IP970H	9IP	70	H	2.5	10	447236
B35IP990H	9IP	90	H	2.5	10	447243
B35IP9152H	9IP	152	H	2.5	10	447226
B35IP1090H	10IP	90	H	2.74	10	447244
B35IP10152H	10IP	152	H	2.74	10	447254
B35IP1549H	15IP	49	H	3.27	10	447230
B35IP1570H	15IP	70	H	3.27	10	447237
B35IP1590H	15IP	90	H	3.27	10	447245
B35IP15152H	15IP	152	H	3.27	10	447255
B35IP2049H	20IP	49	H	3.86	10	447231
B35IP2070H	20IP	70	H	3.86	10	447238
B35IP2090H	20IP	90	H	3.86	10	447246
B35IP20152H	20IP	152	H	3.86	10	447256
B35IP2549H	25IP	49	H	4.43	10	447232
B35IP2570H	25IP	70	H	4.43	10	447239
B35IP2590H	25IP	90	H	4.43	10	447247
B35IP25152H	25IP	152	H	4.43	10	447257
B35IP3049H	30IP	49	H	5.52	10	447234
B35IP3070H	30IP	70	H	5.52	10	447241
B35IP3090H	30IP	90	H	5.52	10	447249
B35IP30152H	30IP	152	H	5.52	10	447259
B35IP4049H	40IP	49	H	6.65	10	447235
B35IP4070H	40IP	70	H	6.65	10	447242
B35IP4090H	40IP	90	H	6.65	10	447250
B35IP40152H	40IP	152	H	6.65	10	447260

## 1/4" Hex Power BIT



Model No.	Tip Size	Overall Length	Hardness	Inner Ctn.	Code
B35P123H	PH1	23	H	10	424131
B35P223H	PH2	23	H	10	424141
B35P240H	PH2	40	H	10	424143
B35P2100H	PH2	100	H	10	424147

## 1/4" Hex Power BIT



Model No.	Tip Size	Overall Length	Hardness	Body Diameter	Inner Ctn.	Code
B35PZ14850H	PZ1	50	4.8	H	10	424101
B35PZ26350H	PZ2	50	6.3	H	10	424102
B35PZ3850H	PZ3	50	8	H	10	424103

\* All dimensions are in metric. Please contact us if you'd like to know it in imperial.

## 1/4" Hex Power BIT

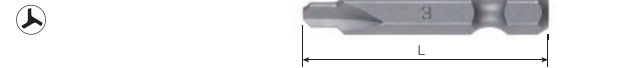

Model No.	Tip Size	Overall Length	Hardness	Inner Ctn.	Code
B35TW140H	TW1	40	H	10	424201
B35TW240H	TW2	40	H	10	424202
B35TW340H	TW3	40	H	10	424203
B35TW440H	TW4	40	H	10	424204

## 1/4" Hex NECK TORSION™ Mag Catcher Power Bit

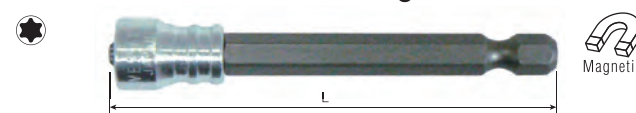

Model No.	Tip Size	Overall Length	Inner Ctn.	Code
B35MMBCT1049H	T10	49	10	447111
B35MMBCT1070H	T10	70	10	447112
B35MMBCT1549H	T15	49	10	447115
B35MMBCT1570H	T15	70	10	447116
B35MMBCT2049H	T20	49	10	447113
B35MMBCT2075H	T20	75	10	447101
B35MMBCT20150H	T20	150	10	447109
B35MMBCT2549H	T25	49	10	447117
B35MMBCT2570H	T25	70	10	447118

## 1/4" Hex NECK TORSION™ Mag Catcher Insert Bit Replacement Bit

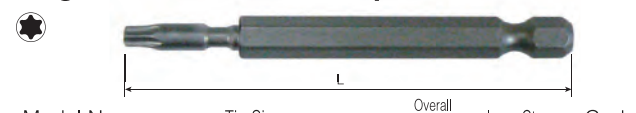

Model No.	Tip Size	Overall Length	Inner Ctn.	Code
B35MMBCT1049HRB	T10	49	10	447337
B35MMBCT1070HRB	T10	70	10	447338
B35MMBCT1549HRB	T15	49	10	447361
B35MMBCT1570HRB	T15	70	10	447362
B35MMBCT2049HRB	T20	49	10	447339
B35MMBCT2075HRB	T20	75	10	447340
B35MMBCT20150HRB	T20	150	10	447341

## 1/4" Hex Power Bit Reduced Shaft

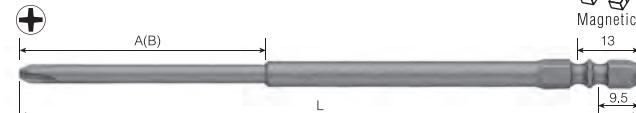

Model No.	Tip Size	Overall Length	Length (A(B))	Hardness	Body Diameter	Inner Ctn.	Code
MAB16P24565H	PH2	65	40	H	4.5	10	415301
MAB16P245100H	PH2	100	75	H	4.5	10	415302
MAB16P245150H	PH2	150	50(75)	H	4.5	10	415303

## MAGNETIC SCREW CATCHER

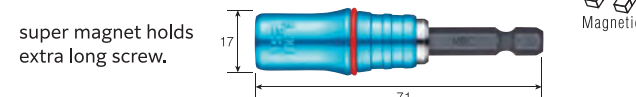

Model No.	Overall Length	Inner Ctn.	Code
MBCAF63571	71	1PC	486345

# Double-Ended Power Bits

Drive : 1/4 DIN 3126-E6.3, ISO 1173  H 6.35mm

## 1/4" Hex Double-Ended Power BIT



Model No.	Tip Size	Overall Length	Hardness	Inner Ctn.	Code
B43P175H	PH1	75	H	10	425032
B43P250X	PH2	50	X	10	425036
B43P250H	PH2	50	H	10	425037
B43P250E	PH2	50	E	10	425038
B43P275X	PH2	75	X	10	425039
B43P275H	PH2	75	H	10	425040
B43P275G	PH2	75	G	10	425041
B43P275E	PH2	75	E	10	425042
B43P2100X	PH2	100	X	10	425046
B43P2100H	PH2	100	H	10	425047
B43P2100G	PH2	100	G	10	425043
B43P2100E	PH2	100	E	10	425044
B43P2150X	PH2	150	X	10	425048
B43P2150H	PH2	150	H	10	425049
B43P2150G	PH2	150	G	10	425045
B43P2200G	PH2	200	G	10	425050
B43P2300H	PH2	300	H	10	446373
B43P375H	PH3	75	H	10	425054
B43P375E	PH3	75	E	10	425055
B43P3100H	PH3	100	H	10	425057
B43P3100E	PH3	100	E	10	425058
B43P3150H	PH3	150	H	10	446375

## 1/4" Hex Double-Ended Power BIT



Model No.	Tip Size	Overall Length	Hardness	Inner Ctn.	Code
MB43P275H	PH2	75	H	10	446669
MB43P2100H	PH2	100	H	10	446672
MB43P2150H	PH2	150	H	10	446673

## 1/4" Hex Double-Ended Power BIT



Model No.	Tip Size	Overall Length	Hardness	Inner Ctn.	Code
B43PP275H	PH2	75	H	10	425171
B43PP2100H	PH2	100	H	10	425172

## 1/4" Hex Double-Ended Power BIT



Model No.	Tip Size	Overall Length	Hardness	Inner Ctn.	Code
B43HP275H	PH2	75	H	10	425151
B43HP2100H	PH2	100	H	10	425153
B43HP2150H	PH2	150	H	10	425155

## 1/4" Hex Double-Ended Power BIT



Model No.	Tip Size	Overall Length	Hardness	Inner Ctn.	Code
B43BP250S	PH2	50	S	10	425141
B43BP275S	PH2	75	S	10	425142
B43BP2100S	PH2	100	S	10	425143
B43BP2150S	PH2	150	S	10	425144

## 1/4" Hex Double-Ended Power BIT

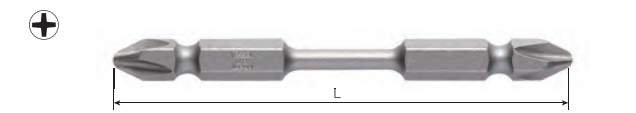

Model No.	Tip Size	Overall Length	Hardness	Body Diameter	Inner Ctn.	Code
BT43P275H	PH2	75	H	Torsion	10	425161
BT43P2100H	PH2	100	H	Torsion	10	425162

## 1/4" Hex Double-Ended Power BIT

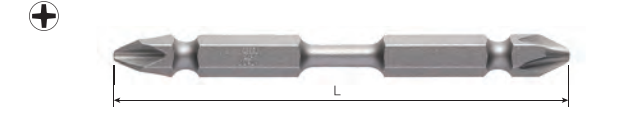

Model No.	Tip Size	Overall Length	Hardness	Body Diameter	Inner Ctn.	Code
BT43PP275X	PH2	75	X	Torsion	10	425201
BT43PP2100X	PH2	100	X	Torsion	10	425202

## Selecting best fit Phillips tip\* for various screw types

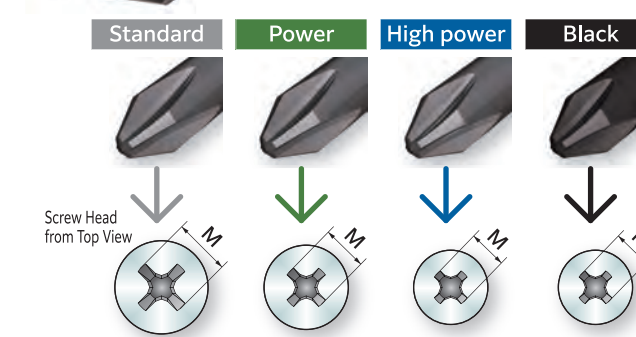
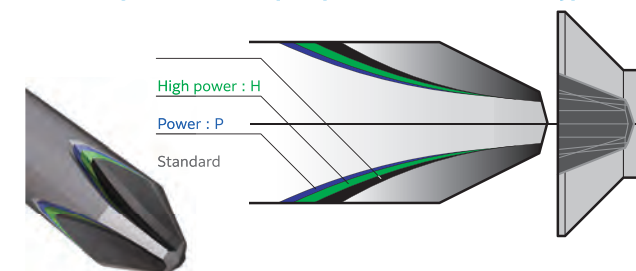

0.165~0.217 inch (4.2~5.5mm) 0.126~0.165 inch (3.2~4.2mm) 0.106~0.126 inch (2.7~3.2mm) 0.106~0.126 inch (2.7~3.2mm)

\* M dimension : width across flats of screw recess from the top view  
\* Phillips is a registered trademark of Phillips Screw Co.

\* All dimensions are in metric. Please contact us if you'd like to know it in imperial.

# Nut Setters



Drive : 1/4 DIN 3126-C6.3, ISO 1173 H 6.35 mm

## Nutsetter 1/4" Hex Nutsetter Metric

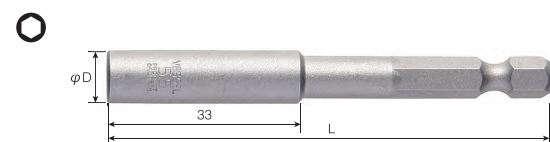

Model No.	Socket Size	Overall Length	Socket Nose Diameter φ	Inner Ctn.	Code
B45AF450	A/F4	50	8	10	489301
B45AF475	A/F4	75	8	10	489314
B45AF4100	A/F4	100	8	10	489327
B45AF4550	AF/4.5	50	8	10	489302
B45AF550	AF/5	50	8	10	489303
B45AF575	AF/5	75	8	10	489316
B45AF5100	AF/5	100	8	10	489329
B45AF5550	A/F5.5	50	9	10	489304
B45AF5575	A/F5.5	75	9	10	424281
B45AF55100	A/F5.5	100	9	10	424380
B45AF55150	A/F5.5	150	9	10	424265 ☆
B45AF650	A/F6	50	10	10	489305
B45AF675	A/F6	75	10	10	424282 ☆
B45AF6100	A/F6	100	10	10	424381
B45AF6150	A/F6	150	10	10	424266 ☆
B45AF750	A/F7	50	13.5	10	489306
B45AF71175	A/F7	75	11	10	424279
B45AF775	A/F7	75	13.5	10	424283 ☆
B45AF711100	A/F7	100	11	10	424280
B45AF7100	A/F7	100	13.5	10	424382 ☆
B45AF7150	A/F7	150	13.5	10	424267 ☆
B45AF850	A/F8	50	13.5	10	489307
B45AF875	A/F8	75	13.5	10	424284 ☆
B45AF8100	A/F8	100	13.5	10	424383 ☆
B45AF8150	A/F8	150	13.5	10	424483 ☆
B45AF950	A/F9	50	16	10	489308
B45AF1050	A/F10	50	16	10	489309
B45AF1075	AF/10	75	16	10	424286 ☆
B45AF10100	AF/10	100	16	10	424384 ☆
B45AF10150	AF/10	150	16	10	424484 ☆
B45AF1150	A/F11	50	17	10	489310
B45AF1175	A/F11	75	17	10	424270 ☆
B45AF11100	A/F11	100	17	10	424271 ☆
B45AF1250	A/F12	50	18	10	489311
B45AF1275	A/F12	75	18	10	424287 ☆
B45AF12100	A/F12	100	18	10	424385 ☆
B45AF12150	A/F12	150	18	10	424272 ☆
B45AF1350	A/F13	50	19	10	489312
B45AF1375	AF/13	75	19	10	424288 ☆
B45AF13100	AF/13	100	19	10	424386 ☆
B45AF1450	A/F14	50	20	10	489313
B45AF1475	A/F14	75	20	10	424289 ☆
B45AF14100	A/F14	100	20	10	424387 ☆

☆ = Adopts a patented axial press-fit shank technique.

## Nutsetter 1/4" Hex Magnet Nutsetter Metric

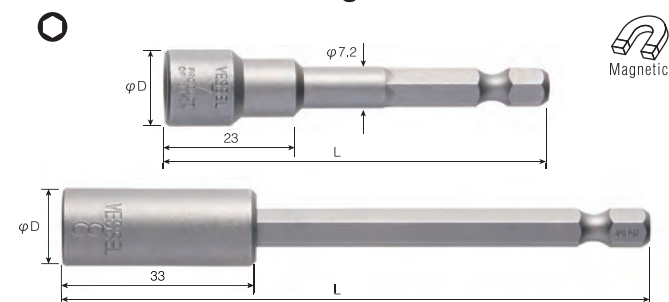

Model No.	Socket Size	Overall Length	Socket Nose Diameter φ	Inner Ctn.	Code
MB45AF550	A/F5	50	8.5	10	489340
MB45AF575	A/F5	75	8.5	10	489351
MB45AF5100	A/F5	100	8.5	10	489362
MB45AF5550	A/F5.5	50	9	10	489341
MB45AF5575	A/F5.5	75	9	10	489352
MB45AF650	A/F6	50	10	10	489342
MB45AF675	A/F6	75	10	10	489353
MB45AF6100	A/F6	100	10	10	489364
MB45AF750	A/F7	50	13	10	489343
MB45AF765	A/F7	65	13	10	482520
MB45AF775	A/F7	75	13	10	489354
MB45AF7100	A/F7	100	13	10	489365
MB45AF7150	A/F7	150	13.5	10	446622
MB45AF850	A/F8	50	13.5	10	489344
MB45AF865	A/F8	65	13.5	10	482521 ☆
MB45AF875	A/F8	75	13.5	10	482523
MB45AF8100	A/F8	100	13.5	10	482524 ☆
MB45AF8150	A/F8	150	13.5	10	424274 ☆
MB45AF950	A/F9	50	14	10	489345
MB45AF9665	A/F9.6	65	15	10	482522 ☆
MB45AF1050	A/F10	50	16	10	489346
MB45AF1075	A/F10	75	16	10	482525 ☆
MB45AF10100	A/F10	100	16	10	482526 ☆
MB45AF10150	A/F10	150	16	10	424275 ☆
MB45AF1150	A/F11	50	17	10	489347
MB45AF1175	A/F11	75	17	10	489358
MB45AF11100	A/F11	100	17	10	489369
MB45AF1250	A/F12	50	19	10	489348
MB45AF1275	A/F12	75	18	10	424276 ☆
MB45AF12100	A/F12	100	18	10	424277 ☆
MB45AF12150	A/F12	150	18	10	424278 ☆
MB45AF1350	A/F13	50	19	10	489349
MB45AF1375	A/F13	75	19	10	489360
MB45AF13100	A/F13	100	19	10	489371
MB45AF13150	A/F13	150	19	10	446626
MB45AF1475	A/F14	75	20	10	489361
MB45AF14100	A/F14	100	20	10	489372

☆ = Adopts a patented axial press-fit shank technique.

## Nutsetter 1/4" Hex Sliding Magnet Nutsetter Metric

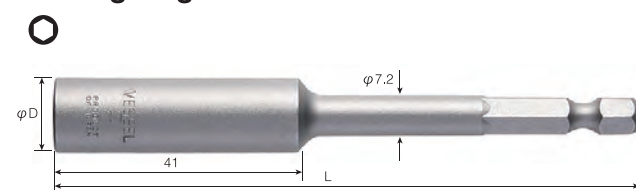

Model No.	Socket Size	Overall Length	Socket Nose Diameter φ	Inner Ctn.	Code
MB45DAF8100	A/F8	100	13	10	482516
MB45DAF10100	A/F10	100	16	10	482517

## Nutsetter 1/4" Hex Side Magnet Nutsetter Metric

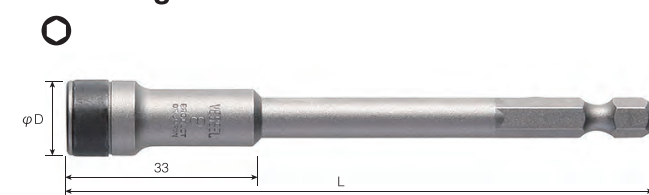

Model No.	Socket Size	Overall Length	Socket Nose Diameter φ	Inner Ctn.	Code
MB45SAF8100	A/F8	100	13	10	482406
MB45SAF10100	A/F10	100	16	10	482407

### Features of press-fit type sockets

(Press-fit type: marked with a star symbol in the table of each model)

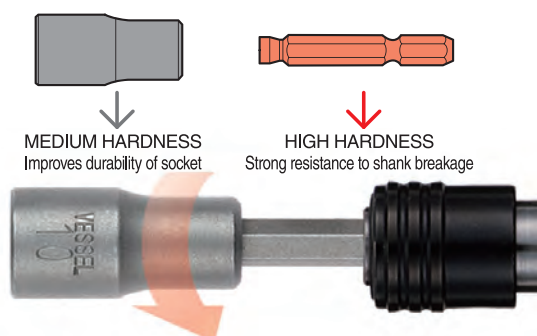

The shank and socket have been heat-treated to the best hardness and press-fit together. The socket part is strong against wear and shank against twisting, resulting in higher durability.

Prevents shank breakage  
Torsion moment with a static torque



# Bit Holder



## TORSION ZONE ABSORB SHOCKS

Torsion part absorbs the impact caused by an impact driver when the screw head is fully seated.

It helps preventing tip breakage as much as possible.

## NECK TORSION

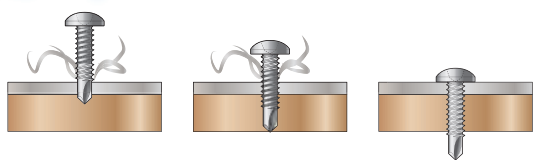

Drive : 1/4 DIN 3126-E6.3, ISO 1173  H 6.35 mm

### Bit Holder 1/4" Hex Magnet Bit Holder



Model No.	Socket Size	Overall Length	Socket Nose Diameter φ	Inner Ctn.	Code
HBM6F63575	6.4(1/4")	75(3")	11.2(7/16")	10	482425

### Bit Holder 1/4" Hex Bit Holder w.C-pin

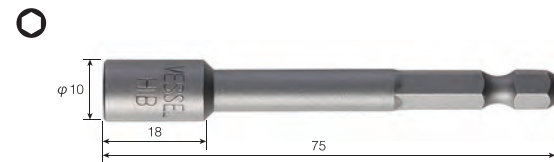

Model No.	Socket Size	Overall Length	Socket Nose Diameter φ	Inner Ctn.	Code
HBAF63575	6.4(1/4")	75(3")	10(13/32")	10	482420

### IMPACT BALL™ Torsion Magnet Bit Holder

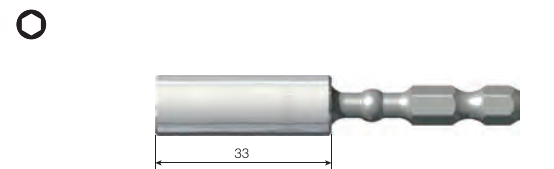

Model No.	Socket Size	Overall Length	Socket Nose Diameter φ	Inner Ctn.	Code
IBHBM67P10K	6.4	67	11.2	10	426099
IBHBM150P10K	6.4	150	11.2	10	426100
IBHBM300P10K	6.4	300	11.2	10	426101

### Hex Socket Adapter



Model No.	Drive Size	Overall Length	Inner Ctn.	Code
B35SA63575	6.35	75	10	487382
B35SA635100	6.35	100	10	487383
B35SA635150	6.35	150	10	487384
B35SA9550	9.6	50	10	487391
B35SA9575	9.6	75	10	487392
B35SA95100	9.6	100	10	487393
B35SA95150	9.6	150	10	487394

# Precision Bits

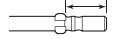
Drive : 4mm HIOS direct drive  φ 4 mm

### Phillips Precision Bit



Model No.	Tip Size	Overall Length	Diameter (d1)	Length (A)	Inner Ctn.	Code
D73P00122040	PH00	40	1.2	20	10	446001
D73P00152040	PH00	40	1.5	20	10	483001
D73P00152060	PH00	60	1.5	20	10	483002
D73P00152080	PH00	80	1.5	20	10	483003
D73P00172040	PH00	40	1.7	20	10	446004
D73P0022040	PH00	40	2	20	10	483005
D73P0022060	PH00	60	2	20	10	483006
D73P0142040	PH0	40	1.4	20	10	446016
D73P0142060	PH0	60	1.4	20	10	446017
D73P0142080	PH0	80	1.4	20	10	483008
D73P0152040	PH0	40	1.5	20	10	446022
D73P0152060	PH0	60	1.5	20	10	446076
D73P0172040	PH0	40	1.7	20	10	483010
D73P0172060	PH0	60	1.7	20	10	483011
D73P0172080	PH0	80	1.7	20	10	483012
D73P0182060	PH0	60	1.8	20	10	483013
D73P022040	PH0	40	2	20	10	446025
D73P022060	PH0	60	2	20	10	446026
D73P023060	PH0	60	2	30	10	446029
D73P022080	PH0	80	2	20	10	446027
D73P0220100	PH0	100	2	20	10	446028
D73P0220120	PH0	120	2	20	10	483014
D73P0252040	PH0	40	2.5	20	10	483015
D73P0252060	PH0	60	2.5	20	10	483016
D73P0252080	PH0	80	2.5	20	10	446033
D73P02520100	PH0	100	2.5	20	10	446034
D73P02520120	PH0	120	2.5	20	10	483017
D73P1252040	PH1	40	3	20	10	446048
D73P132040	PH1	40	3	20	10	483021
D73P132060	PH1	60	3	20	10	446053
D73P132080	PH1	80	2	20	10	446054
D73P1320100	PH1	100	3	20	10	446055
D73P1320120	PH1	120	3	20	10	483376
D73P140	PH1	40	4	-	10	483025
D73P160	PH1	60	4	-	10	446059
D73P180	PH1	80	4	-	10	483026
D73P1100	PH1	100	4	-	10	483027
D73P1120	PH1	120	4	-	10	483028
D73P1150	PH1	150	4	-	10	483029
D73P1200	PH1	200	4	-	10	483032
D73P240	PH2	40	4	-	10	483031
D73P260	PH2	60	4	-	10	446070
D73P280	PH2	80	4	-	10	446071
D73P2100	PH2	100	4	-	10	446072
D73P2120	PH2	120	4	-	10	446073
D73P2150	PH2	150	4	-	10	483033

### Slotted Precision Bit

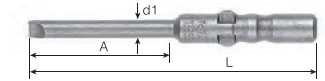

Model No.	Overall Length	Tip Width/ Shank Diameter	Length (A)	Inner Ctn.	Code
D73S20340	40	2	20	10	483041
D73S250340	40	2.5	20	10	483042
D73S30440	40	3	20	10	483043
D73S40540	40	4	-	10	483044

### Hex Precision Bit



Model No.	Tip Size	Overall Length	Diameter (d1)	Length (A)	Inner Ctn.	Code
D73H152060	H1.5	60	2	20	10	483051
D73H232060	H2	60	3	20	10	483052
D73H2532060	H2.5	60	3	20	10	483053
D73H360	H3	60	4	-	100	483054

### Torx Precision Bit

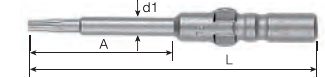

Model No.	Tip Size	Overall Length	Diameter (d1)	Length (A)	Inner Ctn.	Code
D73T1152040	T1	40	1.5	20	10	635621
D73T2152040	T2	40	1.5	20	10	635622
D73T3172040	T3	40	1.7	20	10	635623
D73T4182040	T4	40	1.8	20	10	635624
D73T522040	T5	40	2	20	10	635625
D73T522060	T5	60	2	20	10	446108
D73T6252040	T6	40	2.5	20	10	635626
D73T622040	T6	40	2	20	10	446109
D73T622060	T6	60	2	20	10	446110
D73T7252040	T7	40	2.5	20	10	635627
D73T722060	T7	60	2	20	10	446113
D73T832040	T8	40	3	20	10	635628
D73T932040	T9	40	3	20	10	635629
D73T1032040	T10	40	3	20	10	635630
D73T10H60	T10H	60	4	-	10	446119

# Precision Bits

Drive : 5mm HIOS direct drive

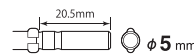

## Phillips Precision Bit

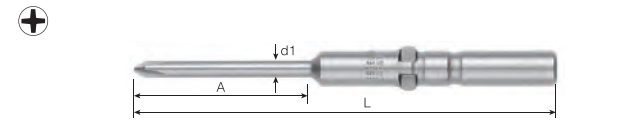

Model No.	Tip Size	Overall Length	Diameter (d1)	Length (A)	Inner Ctn.	Code
D76P0022060	PH00	60	2	20	10	483105
D76P022560	PH0	60	2	25	10	483106
D76P0252560	PH0	60	2.5	25	10	483115
D76P02525100	PH0	100	2.5	25	10	483117
D76P133060	PH1	60	3	30	10	483121
D76P133080	PH1	80	3	30	10	446267
D76P1330100	PH1	100	3	30	10	483122
D76P1330120	PH1	120	3	30	10	483123
D76P160	PH1	60	5	-	10	483125
D76P1100	PH1	100	5	-	10	483127
D76P1200	PH1	200	5	-	10	483132
D76P260	PH2	60	5	-	10	483131
D76P280	PH2	80	5	-	10	446279
D76P2100	PH2	100	5	-	10	446280
D76P2120	PH2	120	5	-	10	446281
D76P2150	PH2	150	5	-	10	446282
D76P2200	PH1	200	5	-	10	483137

## Torx Precision Bit

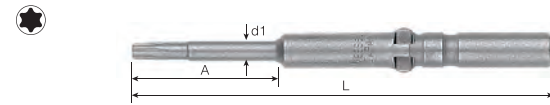

Model No.	Tip Size	Overall Length	Diameter (d1)	Length (A)	Inner Ctn.	Code
D76T522060	T5	60	2	20	10	635651
D76T6252060	T6	60	2.5	20	10	635652
D76T7252060	T7	60	2.5	20	10	635653
D76T832060	T8	60	3	20	10	635654
D76T932060	T9	60	3	20	10	635655
D76T1032060	T10	60	3	20	10	635656
D76T1542060	T15	60	4	20	10	635657
D76T2060	T20	60	5	-	10	635658
D76T2560	T25	60	5	-	10	635659

Drive : 4mm HIOS direct drive

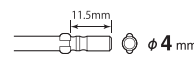

## Nutsetter

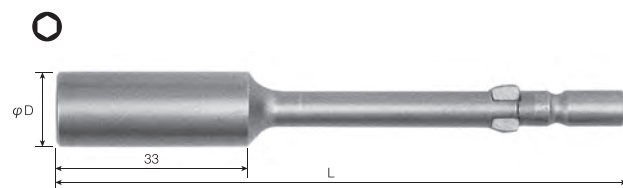

Model No.	Socket Size	Overall Length	Socket Nose Diameter φ	Inner Ctn.	Code
D73AF460	A/F4	60	8	10	483924
D73AF560	A/F5	60	8	10	483926
D73AF5560	A/F5.5	60	8	10	483927

Drive : 4mm half moon direct drive

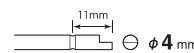

## Phillips Precision Bit

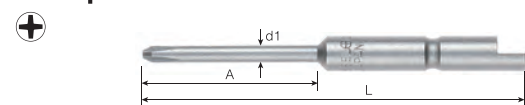

Model No.	Tip Size	Overall Length	Diameter (d1)	Length (A)	Inner Ctn.	Code
D71P001544	PH00	44	1.5	20	10	482901
D71P001564	PH00	64	1.5	20	10	482902
D71P0244	PH0	44	2	20	10	482911
D71P0264	PH0	64	2	20	10	482912
D71P02544	PH0	44	2.5	20	10	482913
D71P02564	PH0	64	2.5	20	10	482914
D71P1344	PH1	44	3	20	10	482921
D71P1364	PH1	64	3	20	10	482922
D71P1444	PH1	44	4	20	10	482923
D71P1464	PH1	64	4	20	10	482924
D71P2444	PH2	44	4	20	10	482931
D71P2464	PH2	64	4	20	10	482932

## Slotted Precision Bit

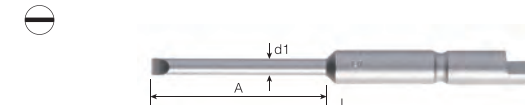

Model No.	Overall Length	Tip Width/ Shank Diameter	Length (A)	Inner Ctn.	Code
D71S20344	44	2	20	10	482941
D71S250344	44	2.5	20	10	482942
D71S30444	44	3	20	10	482943
D71S40544	44	4	20	10	482944

## Hex Precision Bit

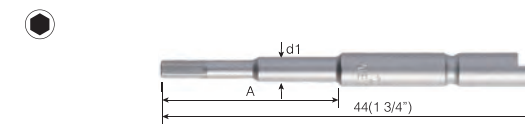

Model No.	Tip Size	Overall Length	Diameter (d1)	Length (A)	Inner Ctn.	Code
D71H15244	H1.5	44	2	20	10	482951
D71H2344	H2	44	3	20	10	482952
D71H25344	H2.5	44	3	20	10	482953
D71H3444	H3	44	4	-	10	482954

## Torx Precision Bit

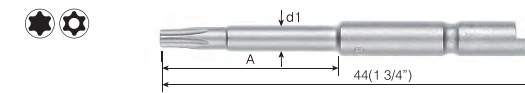

Model No.	Tip Size	Overall Length	Diameter (d1)	Length (A)	Inner Ctn.	Code
D71T144	T1	44	1.5	20	10	635601
D71T244	T2	44	1.5	20	10	635602
D71T344	T3	44	1.7	20	10	635603
D71T444	T4	44	1.8	20	10	635604
D71T544	T5	44	2.5	20	10	635605
D71T644	T6	44	2.5	20	10	635606
D71T744	T7	44	2.5	20	10	635607
D71T844	T8	44	3	20	10	635608
D71T944	T9	44	3	20	10	635609
D71T1044	T10	44	3	20	10	635610
D71T8H44	T8H	44	4	-	10	446323
D71T15H44	T15H	44	4	-	10	446328

## Torx Plus Precision Bit

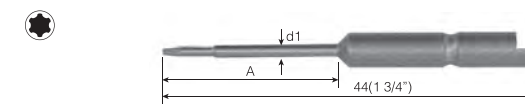

Model No.	Tip Size	Overall Length	Diameter (d1)	Length (A)	Inner Ctn.	Code
D71IP244	2IP	44	4	00	10	447428
D71IP264	2IP	64	4	00	10	447412
D71IP344	3IP	44	4	00	10	447429
D71IP364	3IP	64	4	00	10	447413

## Nutsetter Precision Bit

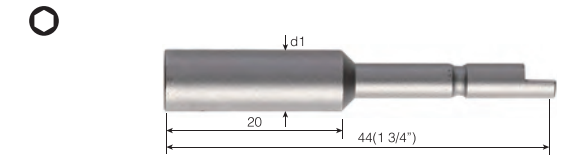

Model No.	Tip Size	Overall Length	Diameter (d1)	Inner Ctn.	Code
D72AF444	A/F4	44	7	10	482961
D72AF4544	A/F4.5	44	7	10	482962
D72AF544	A/F5	44	8	10	482963
D72AF5544	A/F5.5	44	8	10	482964

Drive : M5/M6



## Screw Shank Driver Bit

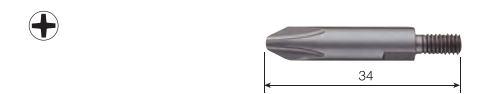

Model No.	Tip Size	Overall Length	Screw Pitch	Inner Ctn.	Code
M4P07P134	PH1	34	P0.7	10	489656
M4P07P234	PH2	34	P0.7	10	489657

## Torx ShoBits for screw fastening robots (Semi-standardized items)



Model No.	Tip Size	Overall Length	Diameter (d1)	Diameter (d2)	Screw Pitch	Inner Ctn.	Code
M5P08P274	PH2	74	5.0	6.0	P0.8	10	483301
M6P1P274	PH2	74	6.0	7.0	P1.0	10	483302

## Torx ShoBits for screw fastening robots (Semi-standardized items)

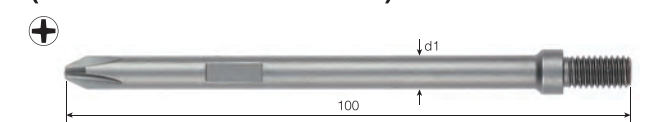

Model No.	Tip Size	Overall Length	Diameter (d1)	Screw Pitch	Inner Ctn.	Code
M6P1P2100	PH2	100	6.0	P1.0	10	483303

## Slotted Precision Bit

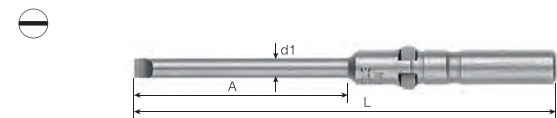

Model No.	Overall Length	Tip Width/ Shank Diameter	Length (A)	Inner Ctn.	Code
D76S30434060	60	3	40	10	483141
D76S40643060	60	4	30	10	483142
D76S50760	60	5	-	10	483143

## Hex Precision Bit

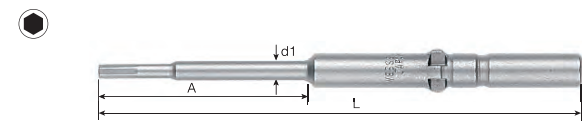

Model No.	Tip Size	Overall Length	Diameter (d1)	Length (A)	Inner Ctn.	Code
D76H233070	H2	70	3	30	10	483151
D76H2533070	H2.5	70	3	30	10	483152
D76H343070	H3	70	4	30	10	483153
D76H470	H4	70	5	-	10	483154